

90k 100k 110k 120k 130k

Gene Span

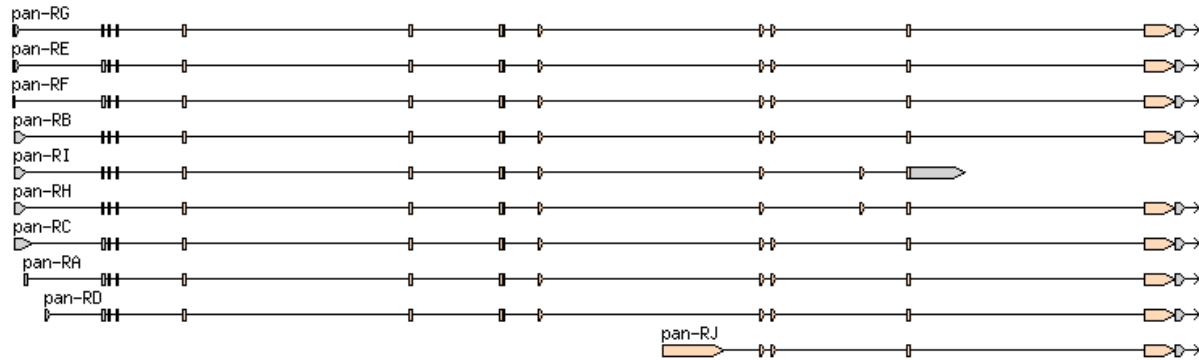

nRNA



Baylor RNAseq exon junctions

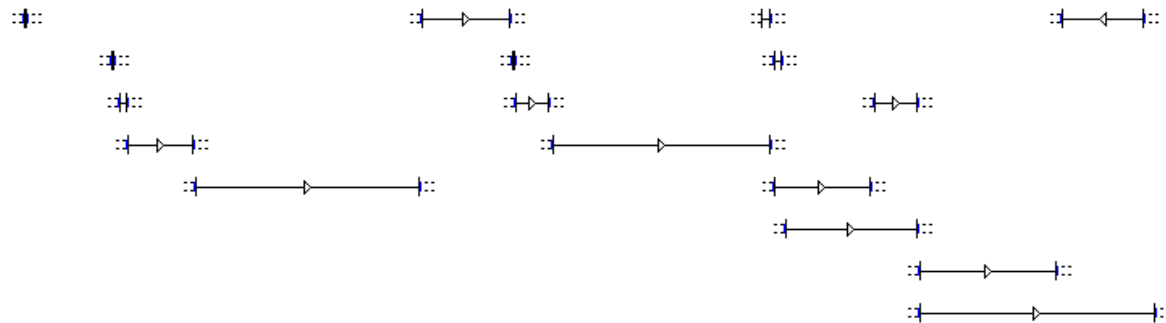

Baylor RNAseq coverage by subsets (dev.stages)

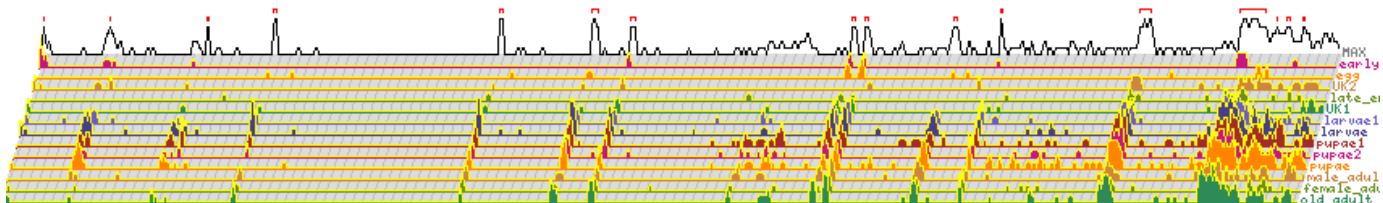

Celniker group RNAseq coverage by subsets (dev.stages)

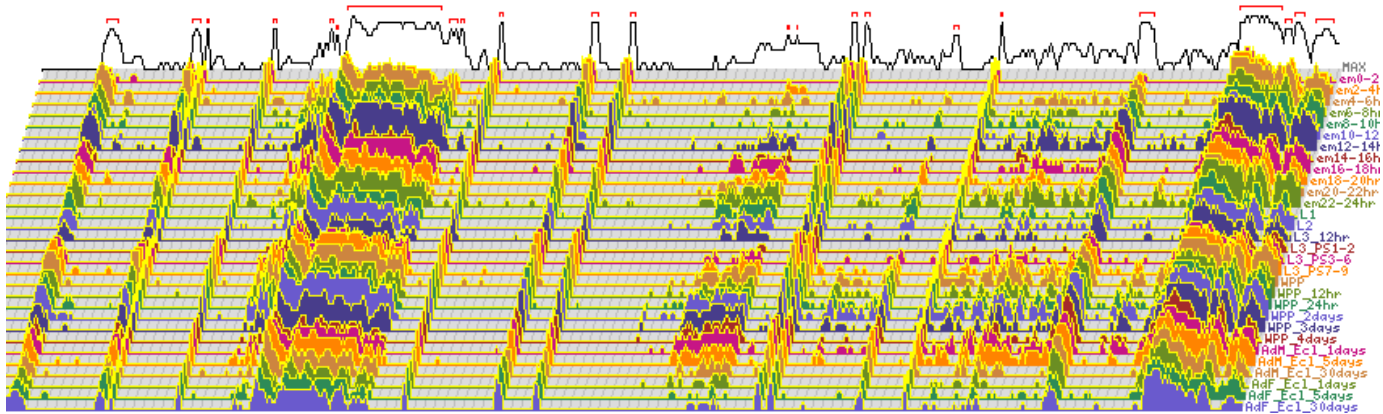

120k 121k 122k 123k 124k 125k 126k 127k 128k 129k

Gene Span



nRNA

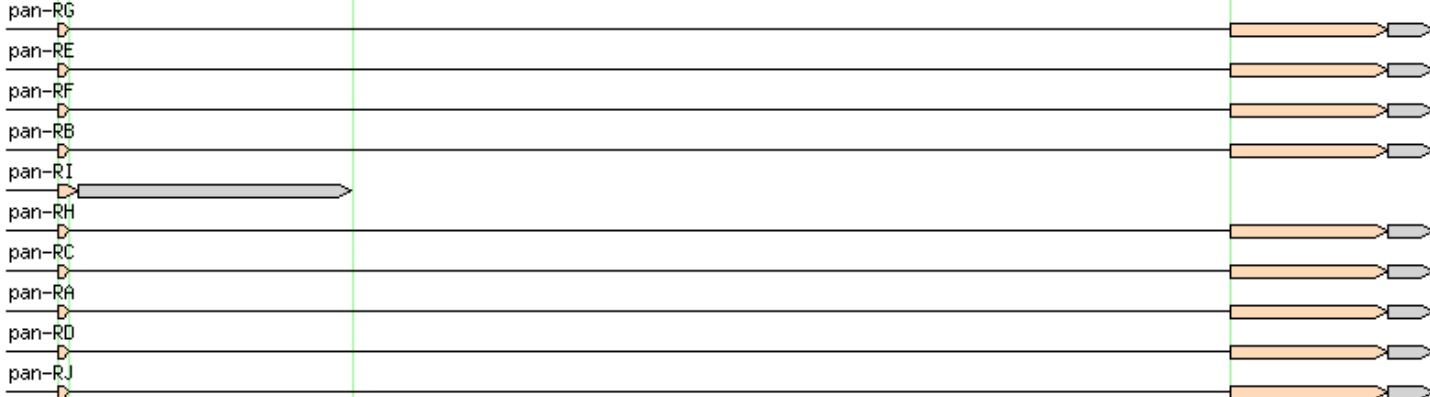

Baylor RNAseq exon junctions



Baylor RNAseq coverage by subsets (dev.stages)

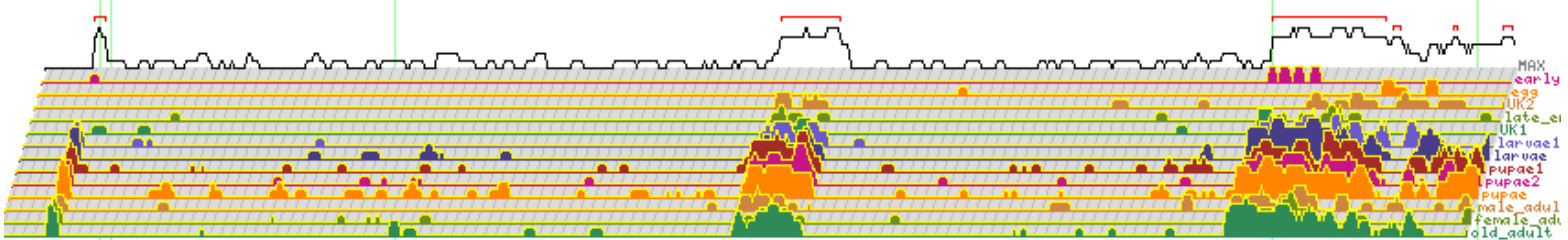

Celniker group RNAseq coverage by subsets (dev.stages)

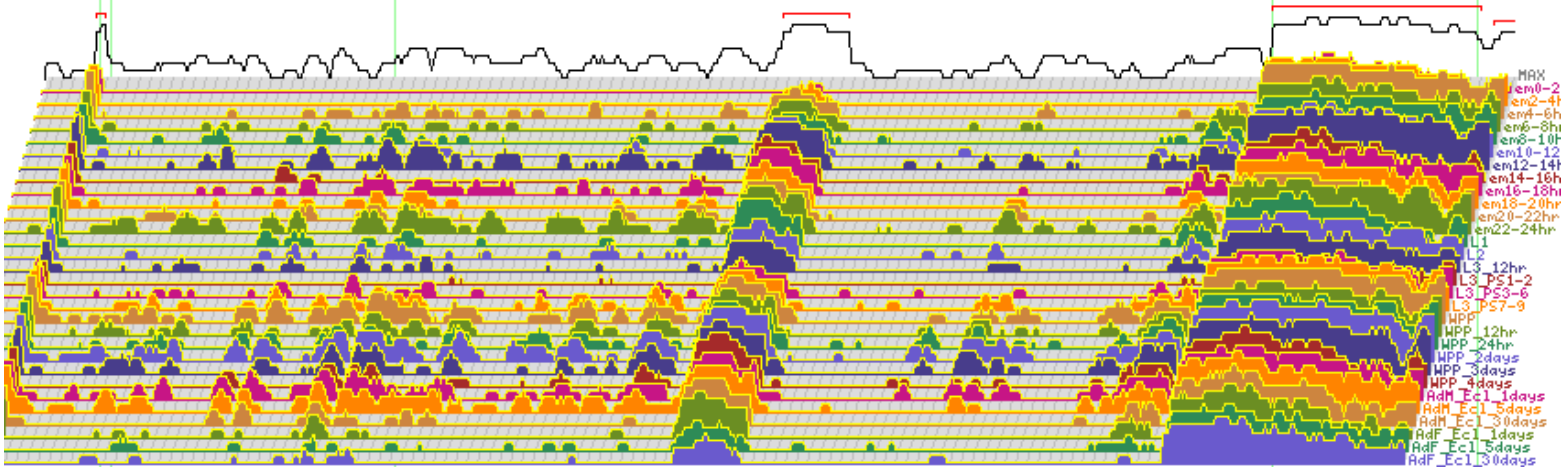

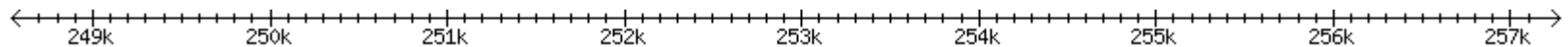

Gene Span
CG32816



mRNA
CG32816-RD



CG32816-RC

Baylor RNAseq exon junctions

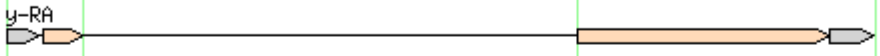

Baylor RNAseq coverage by subsets (dev.stages)

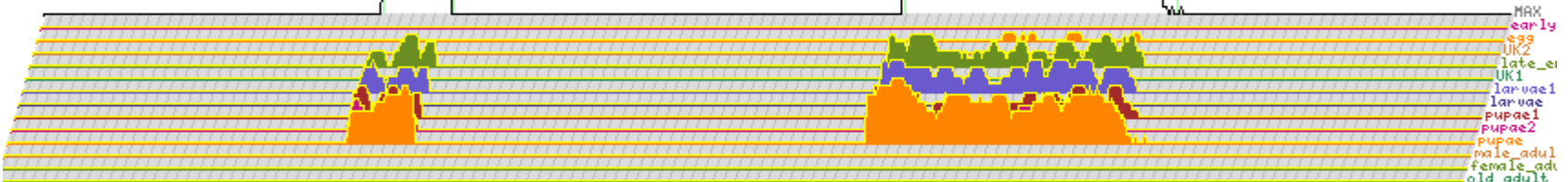

Celniker group RNAseq coverage by subsets (dev.stages)

